

SPECIFICATIONS

FLUID	: Air or neutral gas, filtered and lubricated
PRESSURE	: 2,5 to 10 bar
TEMPERATURE	: +10°C, +40°C
OPERATORS	: Manual
FLOW (Qv at 6 bar)	: 406 l/min (SRA)
Ø NOMINAL	: 4 mm
PORTS	: G 1/8
FUNCTION	: 3/2 NC - 3/2 NO



Operating principle identical to the mechanically operated version (see page P630-11)

CONSTRUCTION

Pilot operated valve features:







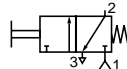
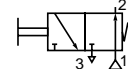
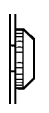

- **snap-action** operation
- low actuating force

Body: light alloy

Internal parts: stainless steel and light alloy

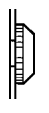
Sealings: nitrile (NBR)

CHOICE OF EQUIPMENT

Panel drilling Ø	Type of operator				CODES		
					COMPLETE PILOT VALVE		
					Function NC 	Function NO 	
-	-	Pilot valve without operating head		-	32000001	32000002	
Ø22	-	Pilot valve with mounting kit for dia. 22 head		-	32000003	32000021	
		Flush push button	Impulse	BLACK	32000004	32000022	
				GREEN	32000005	32000023	
				RED	32000006	32000024	
		Switch	2 fixed positions	$0 \vee 1$	BLACK	32000007	32000025
		Key operated button	Key removal at 0 and 1	$0 \vee 1$	-	32000008	32000026
Ø30		Mushroom push button Ø 40	Impulse	RED	32000009	32000027	
	-	Pilot valve with mounting kit for dia. 30 head		-	32000010	32000028	
		Flush push button	Impulse	BLACK	32000011	32000029	
				GREEN	32000012	32000030	
				RED	32000013	32000031	
		Mushroom push button Ø 40	Impulse	BLACK	32000014	32000032	
				GREEN	32000015	32000033	
				RED	32000016	32000034	
		Mushroom push button Ø 40	Push/turn	RED	32000017	32000035	
		Switch	2 fixed positions	$0 \vee 1$	BLACK	32000018	32000036
	Key operated button	Key removal at 0 and 1	$0 \vee 1$	-	32000019	32000037	

Min. centre-distance for dia. 22 and 30mm operating heads = 45mm. Max. panel thickness = 6mm.

DIMENSIONS AND WEIGHTS

Weight: 0,350 kg

PANEL DRILLING Ø 22,2

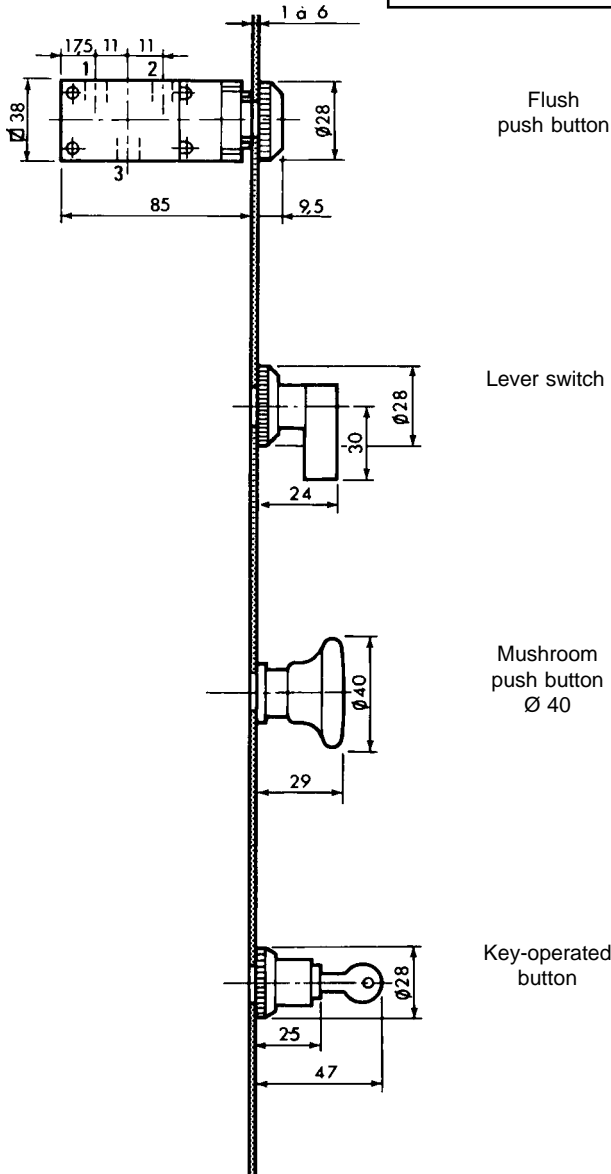

PANEL DRILLING Ø 30,5

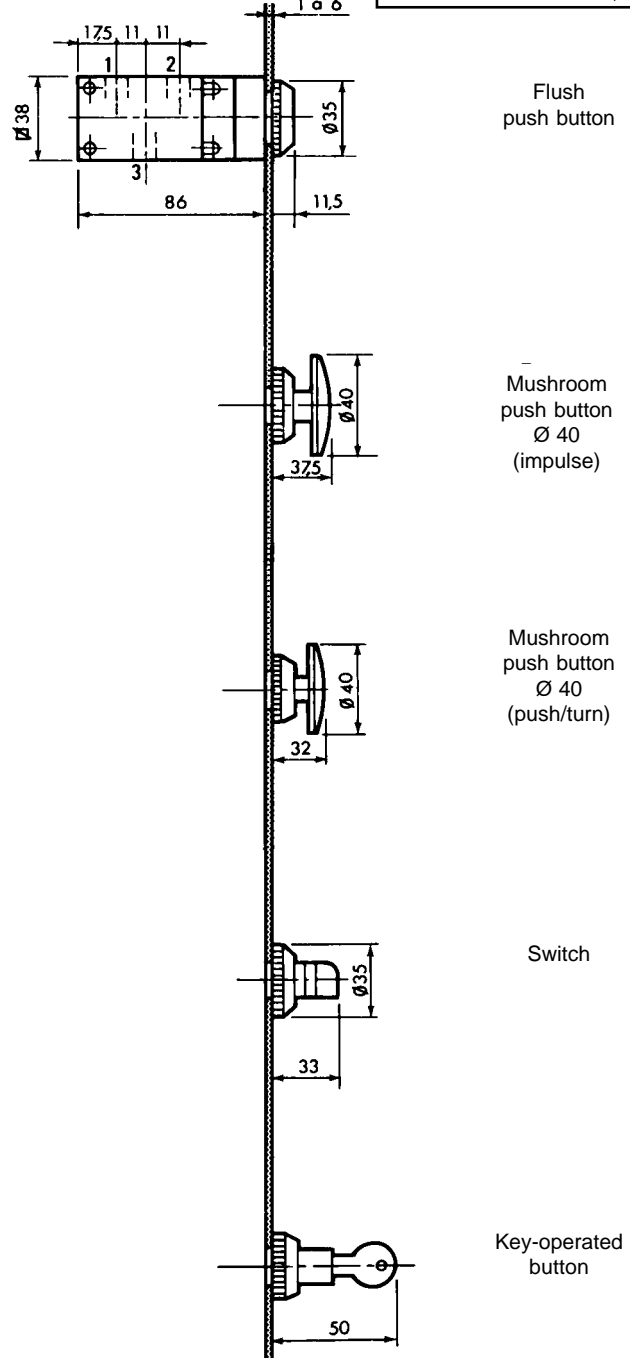

ASSEMBLY

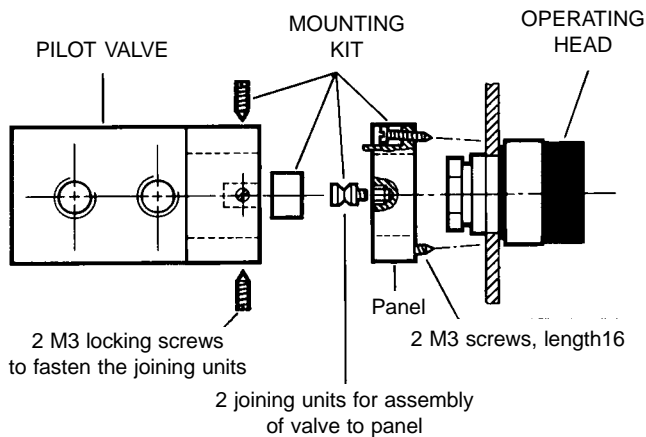

ASSEMBLY

